

# Motore V805 IP54 - V806 IP66

## Motor V805 IP54 - V806 IP66

**S1** SERVIZIO CONTINUO  
CONTINUOUS DUTY **0,55-2,2kW**

Motori C.C. a norme CEI ed IEC - magnete permanente - 4 poli  
D.C. motors CEI and IEC standards - permanent magnet - 4 poles

Alimentazione da batteria - tensione nominale 12/24/48V  
Battery supply - rated voltage 12/24/48V

Fattore di forma 1 - isolamento classe F / H - autoventilato  
Form factor 1 - insulation F / H class - selfventilated

V805 protezione IP54 - V806 protezione IP66  
V805 protection IP54 - V806 protection IP66

V805 uscita cavi o scatola morsetti - V806 solo uscita cavi  
V805 free cables or terminal box - V806 only free cables



Tipo Type	Potenza Power	Tensione/Corrente Voltage/Current	Velocità Speed	Coppia Torque	Potenza Power	Tensione/Corrente Voltage/Current	Velocità Speed	Coppia Torque	Potenza Power	Tensione/Corrente Voltage/Current	Velocità Speed	Coppia Torque
V805.19	0,55 kW	12 V - 55 A	1500 rpm	3,5 Nm	0,75 kW	12 V - 75 A	2200 rpm	3,3 Nm	1,1 kW	12 V - 110 A	3000 rpm	3,5 Nm
		24 V - 27 A				24 V - 37 A				24 V - 55 A		
V806.19		48 V - 14 A				48 V - 19 A				48 V - 27 A		
V805.27	0,75 kW	12 V - 75 A	1500 rpm	4,8 Nm	1 kW	12 V - 100 A	2000 rpm	4,8 Nm	1,1 kW	12 V - 110 A	3000 rpm	3,5 Nm
		24 V - 37 A				24 V - 50 A				24 V - 75 A		
V806.27		48 V - 19 A				48 V - 25 A				48 V - 37 A		4,8 Nm
V805.38	1,1 kW	12 V - 110 A	1500 rpm	7 Nm	1,1 kW	12 V - 110 A	2200 rpm	4,8 Nm	---	---	3000 rpm	---
		24 V - 55 A				24 V - 75 A				24 V - 110 A		
V806.38		48 V - 27 A			1,5 kW	48 V - 37 A		6,5 Nm	2,2 kW	48 V - 55 A		7 Nm

Tolleranza / Tolerance  $\pm 10\%$  Max. 1,1 kW a / at 12 V Max. 2,2 kW a / at 24 V

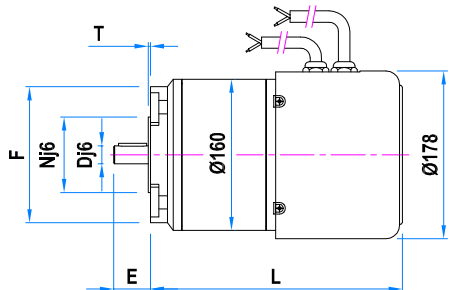

80 B14  
90 B14

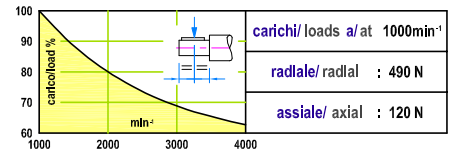
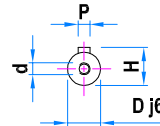
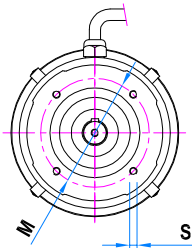

### Alberi / Shafts

D	E	P	H	d
Ø19	40	6x6x30	21,5	M6
Ø24	50	8x7x35	27	M8

### Flange B5 / Flanges B5

F	N	M	T	S
Ø185	Ø130	Ø165	3	10.5

### Flange B14 / Flanges B14

F	N	M	T	S
Ø120	Ø80	Ø100	2.5	M6
Ø140	Ø95	Ø115	3	M8

Tipo / Type	L	Peso / Weight
V805.19 V806.19	267	12.5 Kg
V805.27 V806.27	297	15.5 Kg
V805.38 V806.38	322	19 Kg

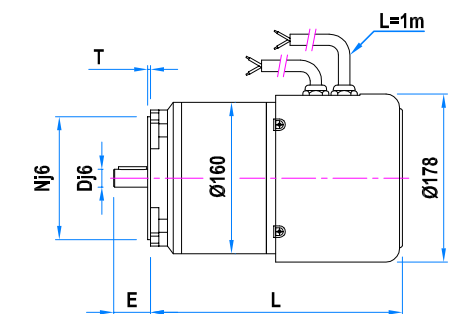

80 B5  
90 B5

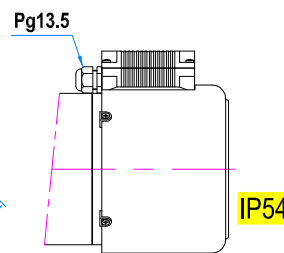
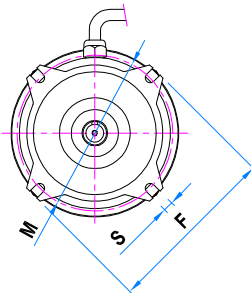

Morsettiera / Terminal box

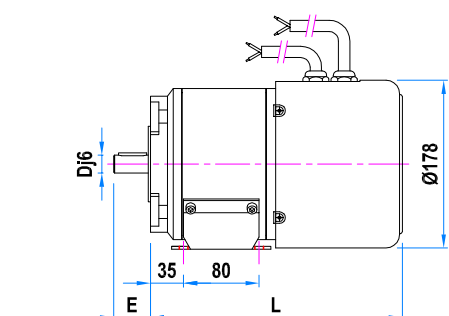

B3

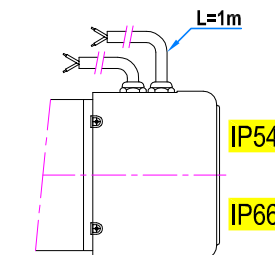
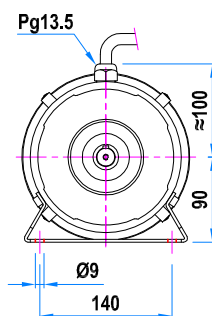

Uscita cavi / Free cables