

Specifications

For other materials or modifications, please consult TESCOM.

OPERATING PARAMETERS

Pressure rating per criteria of ANSI/ASME B31.3

Maximum Inlet Pressure

600 or 3500 psig / 41.4 or 241 bar

Outlet Pressure Ranges

30, 60, 100, 150 psig / 2.1, 4.1, 6.9, 10.3 bar

Design Proof Pressure

150% of maximum rated

Inboard Leak Rate

1×10^{-9} atm cc/sec He

Operating Temperature

PCTFE Seat: -40°F to 140°F / -40°C to 60°C

Teflon® Seat: -40°F to 160°F / -40°C to 71°C

VespeI® Seat: -40°F to 350°F / -40°C to 177°C

Flow Capacity

$C_v = 0.15$ or 0.06

MEDIA CONTACT MATERIALS

Body

316L Stainless Steel Electropolish or 316L VAR Stainless Steel Electropolish

Diaphragm

Nickel Alloy (Hastelloy®)

Valve Seat

PCTFE, PTFE or Polyimide (VespeI®)

Stem and Valve Spring

316 Stainless Steel

Remaining Parts

316 Stainless Steel or Nickel Alloy (Hastelloy®)

OTHER

Internal Surface Finish

10 R_a microinch / 0.25 micrometer

Connections

Welded female or male VCR®

Tube stubs

High Purity Internal Connections (H.P.I.C.)

Internal style of VCR®, compatible with male swivel VCR®

Cleaning

DI water electronic grade cleaned and ES500 Particle Certified for internal electropolish models

Internal Volume

12 cc

Weight

2 lbs / 0.9 kg

Teflon® and VespeI® are registered trademarks of E.I. du Pont de Nemours and Company.

Hastelloy® is a registered trademark of Haynes International, Inc.

VCR® is a registered trademark of Cajon Co.



TESCOM 64-3600 Series ultra high purity, highly sensitive pressure reducing regulator offers a low droop, tied diaphragm design, 10 R_a / 0.25 micrometer surface finish with available Hastelloy® trim. Inlet pressures are 600 or 3500 psig / 41.4 or 241 bar with outlet pressure up to 150 psig / 10.3 bar.

Applications

- 1/4" point-of-use
- Gas cabinets
- Semiconductor manufacturing
- Valve manifold boxes

Features and Benefits

- 10 R_a microinch / 0.25 micrometer internal surface finishes
- Metal-to-metal seal (diaphragm to body seal for high leak integrity)
- Full internal electropolish is available
- Designed to reduce pressure fluctuations in semiconductor gas systems
- Meets the stringent semiconductor requirements of both point-of-use and cylinder applications

NOTE:

When choosing a regulator and control pressure, decaying inlet characteristic must be considered when the supply pressure is expected to change. The decaying inlet characteristic of a pressure reducing regulator is commonly known as the increase in control pressure due to the decrease in supply pressure. It is important to make sure this effect does not cause the control pressure to exceed the pressure rating of the unit's outlet or that of the downstream system.

For more information on decaying inlet, please refer to the Technical Information section of the product catalog and/or contact the TESCOM customer support further assistance.

64-3600 SERIES

64-3600 Series Regulator Drawing

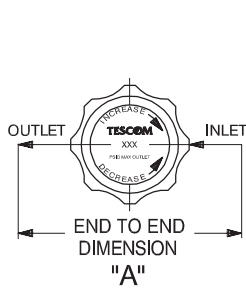
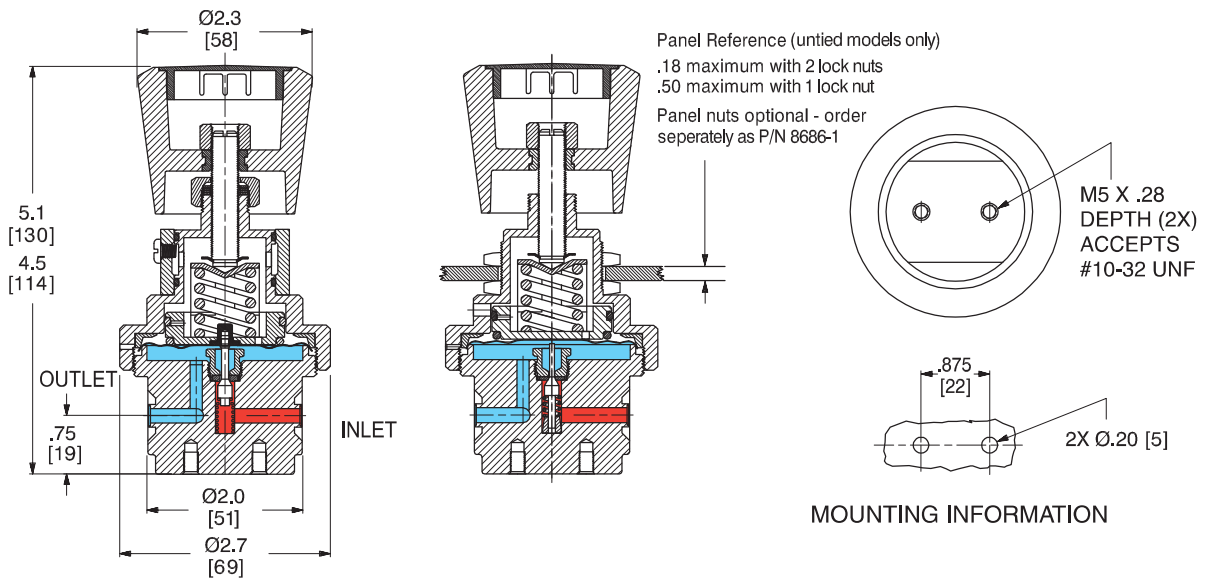

Figure A (no gauges)

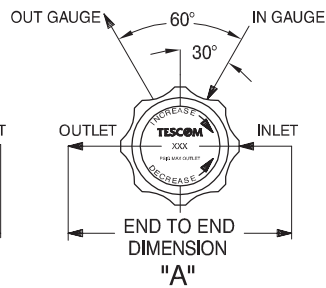

Figure B (2 gauges)

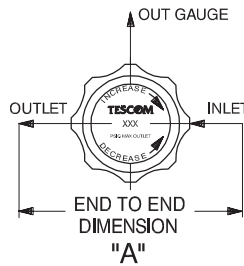

Figure C (1 gauge)

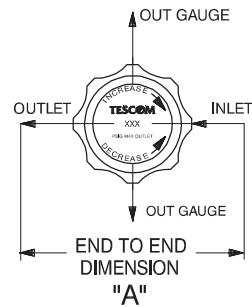
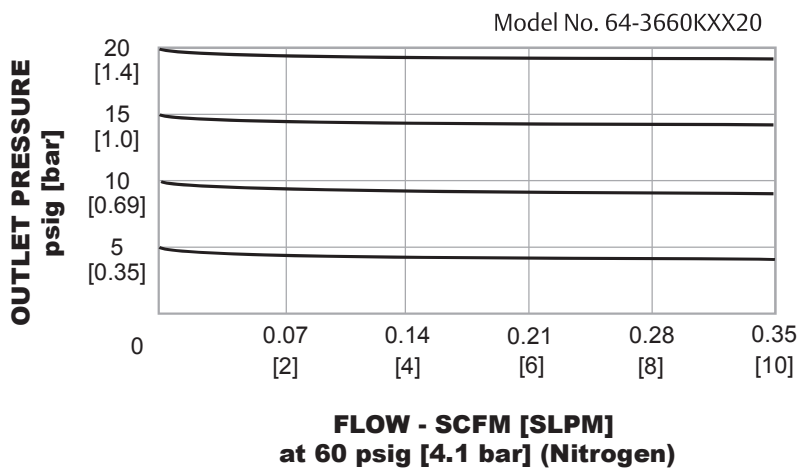
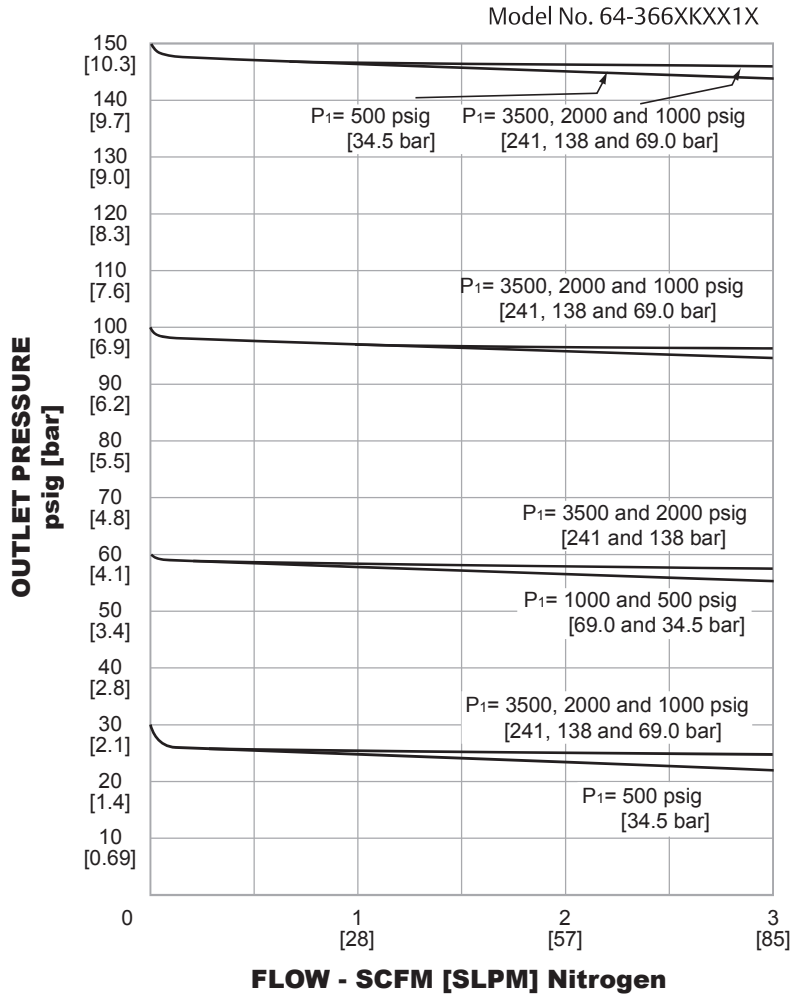

Figure D (2 out gauges)

All dimensions are reference & nominal
 Metric [millimeter] equivalents are in brackets

64-3600 Series Regulator Flow Charts

For more information on how to read flow curves, please refer to the Flow Curves and Calculations document (debul2007x012) in the TESCOM catalog or on www.tescom.com.



64-3600 SERIES

64-3600 Series Regulator Part Number Selector

Repair Kits, Accessories & Modifications may be available for this product. Please contact TESCOM for more information.

Example for selecting a part number:

64-36	6	2	K	A4		2	0	
BASIC SERIES	BODY MATERIAL/ FINISH	OUTLET PRESSURE RANGES	SEAT MATERIAL	INLET AND OUTLET PORT SIZE AND TYPE	'A' ± .06"	SEAL, FLOW (C _v) MAXIMUM INLET PRESSURE	GAUGE PORT OPTIONS	NUMBER OF GAUGE PORTS
64-36	4 – 316L Stainless Steel Electropolish: 10 R _a ¹	0 – 30 psig 2.1 bar	K – PCTFE T – PTFE (untied model only) V – Polyimide (VespeI®)	A4 – 1/4" H.P.I.C.	1.11"	1 – Untied, C _v = 0.06 3500 psig / 241 bar	0 – None	0 (Figure A)
	6 – 316L VAR Stainless Steel Electropolish: 10 R _a ²	1 – 60 psig 4.1 bar		RG – 1/4" Male Swivel	4.50"		2 – Untied, C _v = 0.15 600 psig / 41.4 bar	1 – 1/4" H.P.I.C.
		2 – 100 psig 6.9 bar		RK – 1/2" Male Swivel	4.75"	3 – Tied, C _v = 0.06 3500 psig / 241 bar	2 – 1/4" H.P.I.C.	2 (Figure B)
		3 – 150 psig 10.3 bar		RL – 1/2" Female Swivel	4.75"		4 – 1/4" Male Swivel	2 (Figure D)
				RA – 1/4" Male Fixed	3.51"	4 – Tied, C _v = 0.15 3500 psig / 241 bar	5 – 1/4" Male Swivel	1 (Figure C)
				RM – 1/4" Male Fixed	3.70"		6 – 1/4" Male Swivel	2 (Figure D)
				RT – 1/4" Female Swivel	3.70"	5 – Tied, C _v = 0.15 3500 psig / 241 bar Hastelloy® trim	7 – 1/4" Female Swivel	2 (Figure D)
				RU – IN Port: 1/4" Male Fixed; OUT Port: 1/4" Female Swivel	3.70"		8 – 1/4" Female Swivel	1 (Figure C)
				RV – IN Port: 1/4" Female Swivel; OUT Port: 1/4" Male Fixed	3.70"		9 – 1/4" Female Swivel	2 (Figure B)
				T4 – 1/4" Tube Stubs	3.70"		S – 1/4" Fixed Male	2 (Figure B)
							T – 1/4" Fixed Male	1 (Figure C)
							U – 1/4" Fixed Male	2 (Figure D)

1. Per ASTM B 912
2. Per SEMI F19, HP grade