

Specifications

For other materials or modifications, please consult TESCOM.

OPERATING PARAMETERS

Pressure rating per criteria of ANSI/ASME B31.3

Maximum Inlet Pressure

1000 or 3500 psig / 69.0 or 241 bar

Outlet Pressure Ranges

30, 60, 100, 150 psig / 2.1, 4.1, 6.9, 10.3 bar

Design Proof Pressure

150% of maximum rated

Design Burst Pressure

400% of maximum rated

Inboard Leak Rate

Internal: Bubble-tight

External: 1×10^{-9} atm cc/sec He (ASTM test E499)

Operating Temperature

PCTFE: -40°F to 140°F / -40°C to 60°C

Vespel®: -40°F to 350°F / -40°C to 176°C

Flow Capacity

3500 psig / 241 bar Model: $C_v = 0.06$

1000 psig / 69.0 bar Model: $C_v = 0.15$

MEDIA CONTACT MATERIALS

Body

316L Stainless Steel Electropolish or 316L VAR Stainless Steel Electropolish

Valve Seat

PCTFE

Diaphragm, Stem, Spring

316 Stainless Steel, Nickel Alloy (Hastelloy®)

OTHER

Internal Surface Finish

10 R_a microinch / 0.25 micrometer

Connections

Welded female or male VCR®

Tube stubs

Highly Purity Internal Connections (H.P.I.C.)

(Internal style for VCR®, compatible with male swivel VCR®)

Cleaning

DI water electronic grade cleaned and ES 500 Particle Certified for internal Electropolish models

Internal Volume

5.75 cc

Weight (without gauges)

2 lbs / 0.9 kg

Vespel® is a registered trademark of E.I. du Pont de Nemours and Company.

Hastelloy® is a registered trademark of Haynes International, Inc.

VCR® is a registered trademark of Cajon Co.

NOTE:

When choosing a regulator and control pressure, decaying inlet characteristic must be considered when the supply pressure is expected to change. The decaying inlet characteristic of a pressure reducing regulator is commonly known as the increase in control pressure due to the decrease in supply pressure. It is important to make sure this effect does not cause the control pressure to exceed the pressure rating of the unit's outlet or that of the downstream system.

For more information on decaying inlet, please refer to the Technical Information section of the product catalog and/or contact the TESCOM customer support further assistance.



TESCOM 64-2800 Series high purity, tied diaphragm pressure reducing regulator offers Stainless Steel construction with 10 R_a microinch / 0.25 micrometer surface finish and is electronic grade cleaned. Inlet pressures of 1000 or 3500 psig / 69.0 or 241 bar with outlet pressures up to 150 psig / 10.3 bar.

Applications

- 1/4" point-of-use
- Gas cabinet
- Regulation of specialty gases
- Crystal growing
- Diffusion Furnaces

Features and Benefits

- Positive shutoff minimizes creep
- Metal-to-metal diaphragm to body seal for high leak integrity
- 10 R_a microinch / 0.25 micrometer internal surface finish
- Hastelloy® trim is optional
- Captured bonnet

64-2800 SERIES

64-2800 Series Regulator Drawing

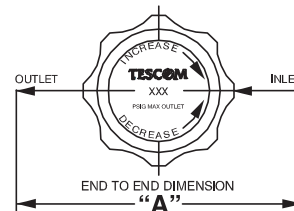
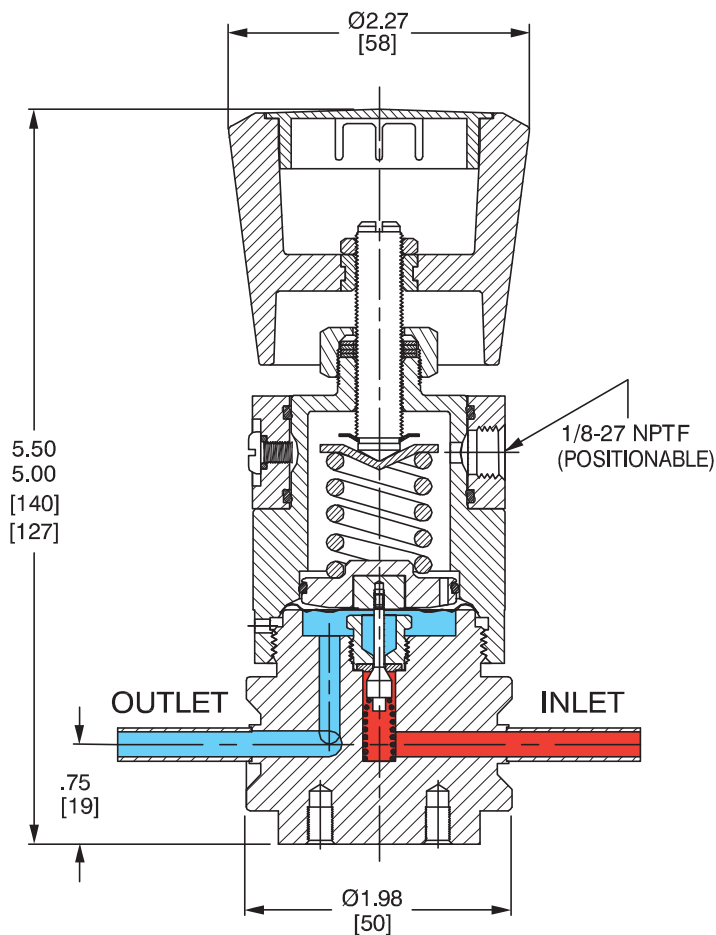

FIGURE A (NO GAUGES)

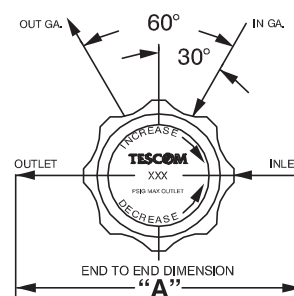

FIGURE B (2 GAUGES)

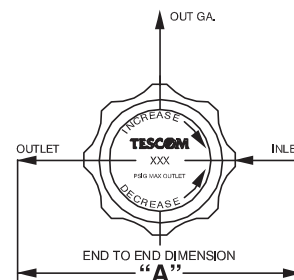

FIGURE C (1 GAUGE)

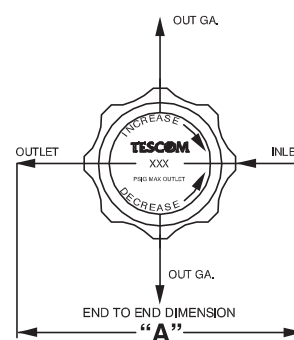
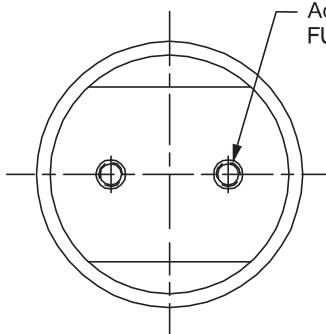
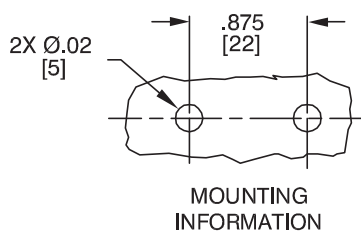

FIGURE D (2 OUT GAUGES)



All dimensions are reference & nominal
Metric [millimeter] equivalents are in brackets

64-2800 Series Regulator Flow Chart

For more information on how to read flow curves, please refer to the Flow Curves and Calculations document (debul2007x012) in the TESCO catalog or on www.tescom.com.

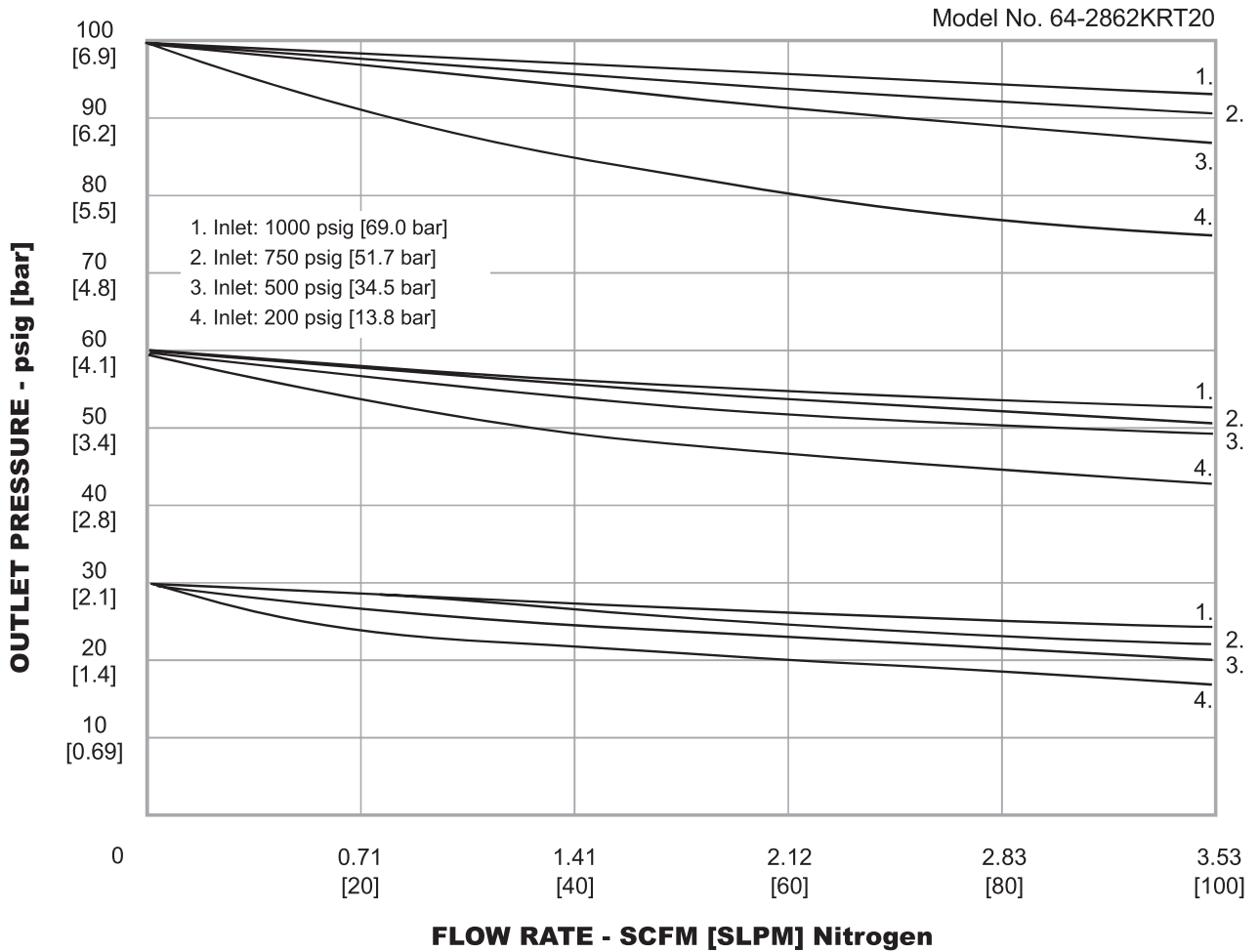

64-2800 SERIES

64-2800 Series Regulator Part Number Selector

Repair Kits, Accessories & Modifications may be available for this product. Please contact TESCOM for more information.

Example for selecting a part number:

64-28 6 2 K A4 1 0

BASIC SERIES	BODY MATERIAL / FINISH	OUTLET PRESSURE RANGES	SEAT MATERIAL	INLET AND OUTLET PORT SIZE AND TYPE	'A' ± .06"	MAXIMUM INLET PRESSURE	GAUGE PORT OPTION	NO. OF GAUGE PORTS (FIGURE)
64-28	4 – 316L Stainless Steel Electropolish: 10 R _A ¹	0 – 30 psig 2.1 bar	K – PCTFE	A4 – 1/4" H.P.I.C.	1.09"	1 – 3500 psig 241 bar	0 – None	0 (Figure A)
	6 – 316L VAR Stainless Steel Electropolish: 10 R _A ²	1 – 60 psig 4.1 bar		RK – 1/2" Male Swivel	4.75"		2 – 1000 psig 69.0 bar	1 – 1/4" H.P.I.C.
		2 – 100 psig 6.9 bar		RL – 1/2" Female Swivel	4.75"	3 – 1000 psig 69.0 bar Hastelloy® trim	2 – 1/4" H.P.I.C.	2 (Figure B)
		3 – 150 psig 10.3 bar		RM – 1/4" Male Swivel	3.70"		3 – 1/4" H.P.I.C.	2 (Figure D)
				RT – 1/4" Female Swivel	3.70"		4 – 1/4" Male Swivel	2 (Figure D)
				RU – IN Port: 1/4" Male; OUT Port: 1/4" Female	3.70"		5 – 1/4" Male Swivel	1 (Figure C)
				RV – IN Port: 1/4" Female; OUT Port: 1/4" Male	3.70"		6 – 1/4" Male Swivel	2 (Figure D)
				T4 – 1/4" Tube Stubs	3.00"		7 – 1/4" Female Swivel	2 (Figure D)
							8 – 1/4" Female Swivel	1 (Figure C)
							9 – 1/4" Female Swivel	2 (Figure B)
							S – 1/4" Fixed Male	2 (Figure B)
							T – 1/4" Fixed Male	1 (Figure C)
							U – 1/4" Fixed Male	2 (Figure D)

1. Per ASTM B 912
2. Per SEMI F19, HP Grade