

## FLOW SWITCH

HD1K

HD1K-008GM005  
Flow-bryter 1/4" 0,5-5 l/m

- 0,5 - 60 l/min vann
- G1/4" - G1"
- Maks. trykk 200 bar
- Forniklet messing / SS304



### PRODUKTBESKRIVELSE

Modell HD1K er en flow switch til væsker og gasser. Den har en skala som viser hvor i arbeidsområdet du har stilt ditt brytepunkt. Flow switchen klarer også veldig viskøse medier noe som gjør at den er meget godt egnet til hydraulikkapplikasjoner.

### TEKNISKE DATA

Flow maks.	10 l/min
Flow maks.	5 l/min
Flow min.	0,5 l/min
IP-klasse	IP65
Kontaktbelastning maks.	50 VA
Materiale fjær	SS301
Materiale hus	Forniklet messing
Materiale stempel	Forniklet messing
Materiale tetninger	NBR
Mediatemperatur til	120 °C
Spenning AC/DC maks.	175 V
Trykkområde maks.	200 bar
Type of flow component	Flowkontakter
Vekt	1,4 kg
Viskositet maks.	150 cSt

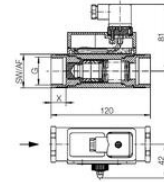
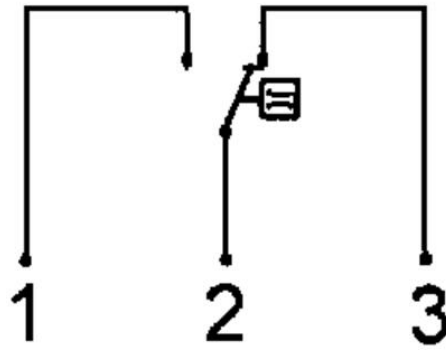
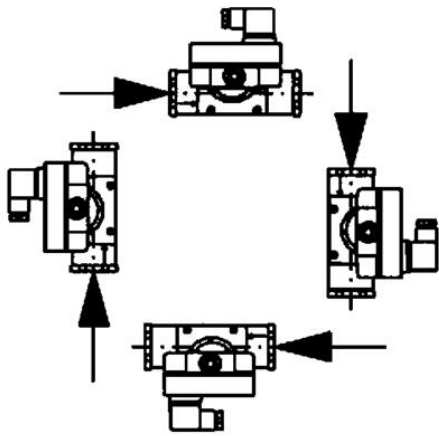

G"	SWIAF mm brass	SWIAF mm stainless	X mm	Weight kg
1/4	40	41	15	1,3
3/8	40	41	15	1,3
1/2	40	41	15	1,2
3/4	40	41	18	1,2
1	40	41	18	1,1



Vatten



Luft/Gas

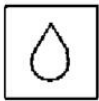

Olja

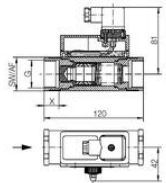
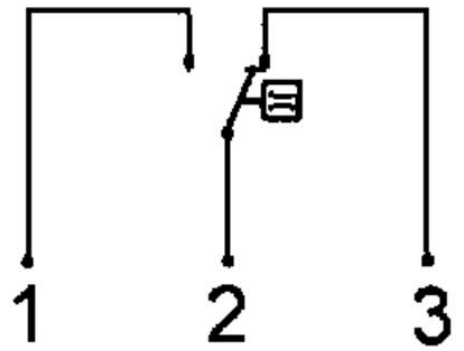
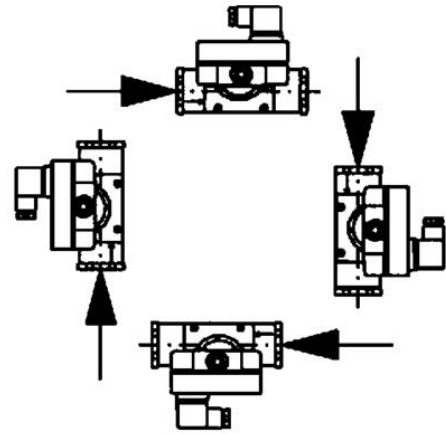

G"	SWIAF mm brass	SWIAF mm stainless	X mm	Weight kg
1/4	40	41	15	1,3
3/8	40	41	15	1,3
1/2	40	41	15	1,2
3/4	40	41	18	1,2
1	40	41	18	1,1

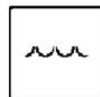

Vatten



Luft/Gas

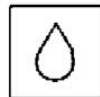

Olja